

Window 8ns High-Speed Comparator



The EL5283 comparator is designed for operation in single supply and dual supply applications with 5V to 12V

between V_{S+} and V_{S-} . For single supplies, the inputs can operate from 0.1V below ground for use in ground-sensing applications.

The output side of the comparators can be supplied from a single supply of 2.7V to 5V. The rail-to-rail output swing enables direct connection of the comparator to both CMOS and TTL logic circuits.

The latch input of the EL5283 can be used to hold the comparator output value by applying a low logic level to the pin.

The EL5283 is a window comparator. A single input is compared with a high reference and a low. When the output goes beyond one of these reference signals, the relevant output goes low.

The EL5283 is available in the 10-pin MSOP package and is specified for operation over the full -40°C to $+85^{\circ}\text{C}$ temperature range. Also available are a single (EL5181) and quad versions (EL5481 and EL5482).

Pinout

**EL5283
(10-PIN MSOP)
TOP VIEW**

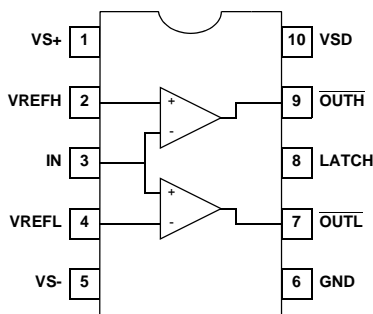

Features

- 8ns typ. propagation delay
- 5V to 12V input supply
- +2.7V to +5V output supply
- True-to-ground input
- Rail-to-rail outputs
- Active low latch
- Single available (EL5181)
- Dual available (EL5281)
- Quad available (EL5481 & EL5482)
- Pin-compatible 4ns family available (EL5x85, EL5287 & EL5486)

Applications

- Threshold detection
- High speed sampling circuits
- High speed triggers
- Line receivers
- PWM circuits
- High speed V/F converters

Ordering Information

PART NUMBER	PACKAGE	TAPE & REEL	PKG. NO.
EL5283CY	10-Pin MSOP	-	MDP0043
EL5283CY-T13	10-Pin MSOP	13"	MDP0043

Absolute Maximum Ratings ($T_A = 25^\circ\text{C}$)

Analog Supply Voltage (V_{S+} to V_{S-}) +12.6V
 Digital Supply Voltage (V_{SD} to GND) +7V
 Differential Input Voltage [(V_{S-}) -0.2V] to [(V_{S+}) +0.2V]
 Common-mode Input Voltage [(V_{S-}) -0.2V] to [(V_{S+}) +0.2V]
 Latch Input Voltage -0.2V to [(V_{SD}) +0.2V]

Storage Temperature Range -65°C to +150°C
 Ambient Operating Temperature -40°C to +85°C
 Operating Junction Temperature 125°C
 Power Dissipation See Curves

CAUTION: Stresses above those listed in "Absolute Maximum Ratings" may cause permanent damage to the device. This is a stress only rating and operation of the device at these or any other conditions above those indicated in the operational sections of this specification is not implied.

IMPORTANT NOTE: All parameters having Min/Max specifications are guaranteed. Typical values are for information purposes only. Unless otherwise noted, all tests are at the specified temperature and are pulsed tests, therefore: $T_J = T_C = T_A$

Electrical Specifications $V_S = \pm 5V$, $V_{SD} = 5V$, $R_L = 2.3k\Omega$, $T_A = 25^\circ\text{C}$, unless otherwise specified.

PARAMETER	DESCRIPTION	CONDITION	MIN	TYP	MAX	UNIT
INPUT						
V_{OS}	Input Offset Voltage	$V_{CM} = 0V$, $V_O = 2.5V$		1	4	mV
I_B	Input Bias Current		-6	-3.5		μA
C_{IN}	Input Capacitance			5		pF
V_{CM}	Input Voltage Range		(V_{S-}) - 0.1		(V_{S+}) - 2.25	V
CMRR	Common-mode Rejection Ratio	$-5.1V < V_{CM} < +2.75V$	65	90		dB
OUTPUT						
V_{OH}	Output High Voltage	$V_{IN} > 250mV$	$V_{SD} - 0.6$	$V_{SD} - 0.4$		V
V_{OL}	Output Low Voltage	$V_{IN} > 250mV$		GND + 0.25	GND + 0.5	V
DYNAMIC PERFORMANCE						
t_{PD+}	Positive Going Delay Time	$V_{IN} = 1V_{P-P}$, $V_{OD} = 50mV$		8	12	ns
t_{PD-}	Negative Going Delay Time	$V_{IN} = 1V_{P-P}$, $V_{OD} = 50mV$		8	12	ns
SUPPLY						
I_{S+}	Positive Analog Supply Current	Per comparator		7	8.2	mA
I_{S-}	Negative Analog Supply Current	Per comparator		5	6.5	mA
I_{SD}	Digital Supply Current at No Load	Per comparator, output high		4	5	mA
		Per comparator, output low		0.75	1	mA
PSRR	Power Supply Rejection Ratio		60	80		dB
LATCH						
V_{LH}	Latch Input Voltage High				2.0	V
V_{LL}	Latch Input Voltage Low		0.8			V
I_{LH}	Latch Input Current High	$V_{LH} = 3.0V$	-50	-30		μA
I_{LL}	Latch Input Current Low	$V_{LL} = 0.3V$	-50	-40		μA
t_{D+}	Latch Disable to High Delay			6		ns
t_{D-}	Latch Disable to Low Delay			6		ns
t_S	Minimum Setup Time			2		ns
t_H	Minimum Hold Time			1		ns
$t_{PW(D)}$	Minimum Latch Disable Pulse Width			10		ns

Typical Performance Curves

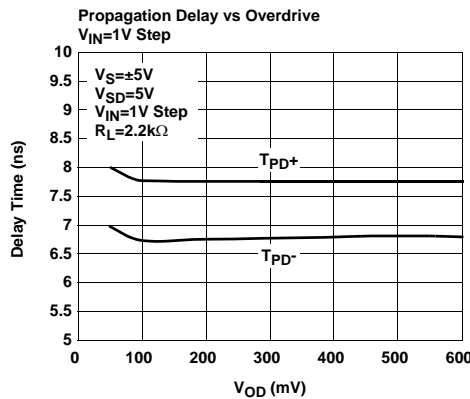
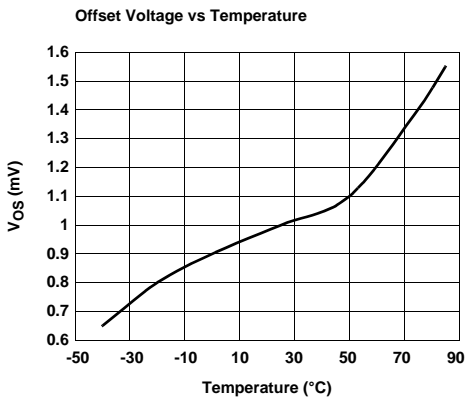
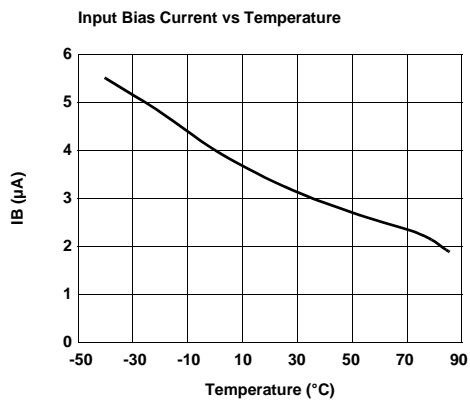
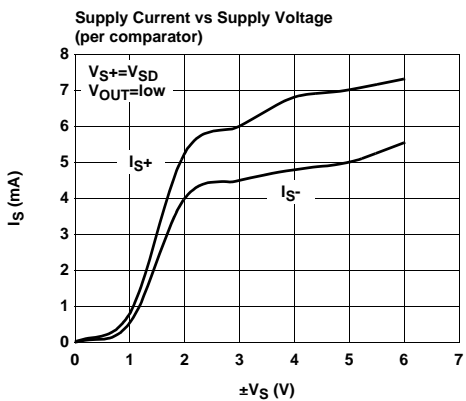
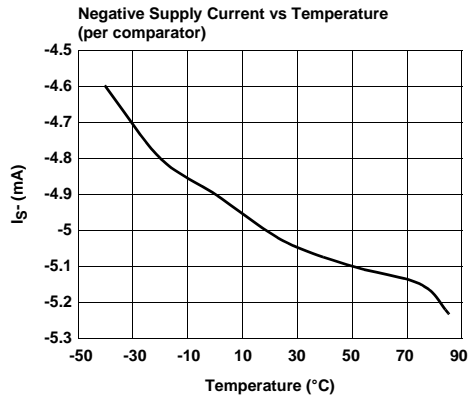
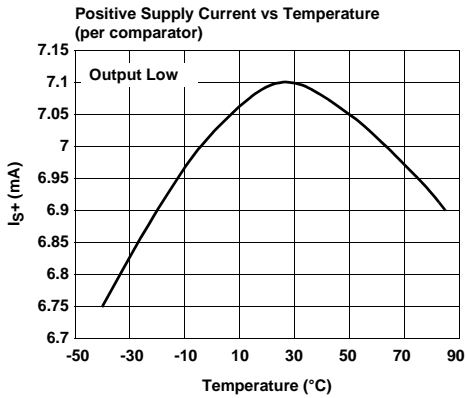

Typical Performance Curves (Continued)

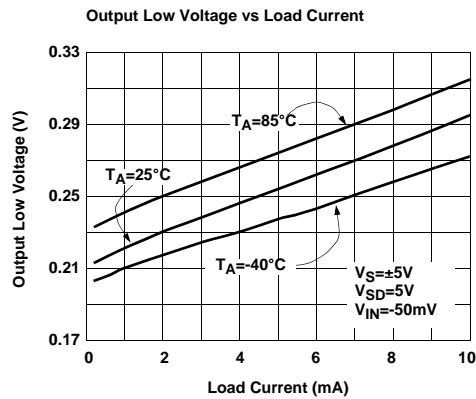
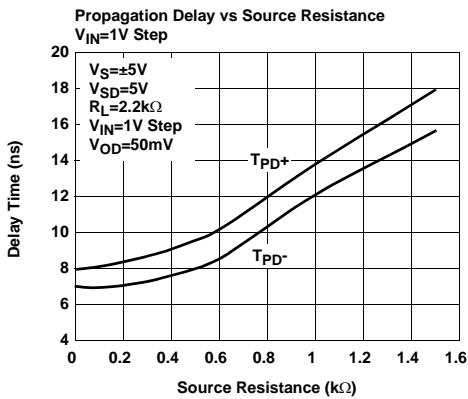
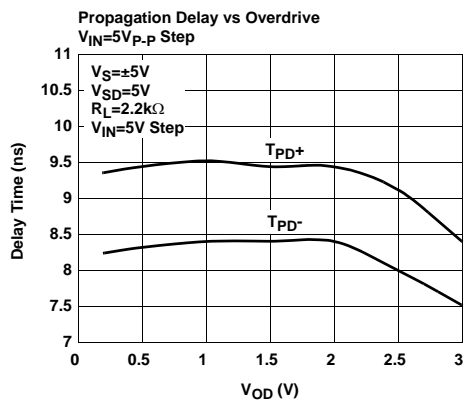
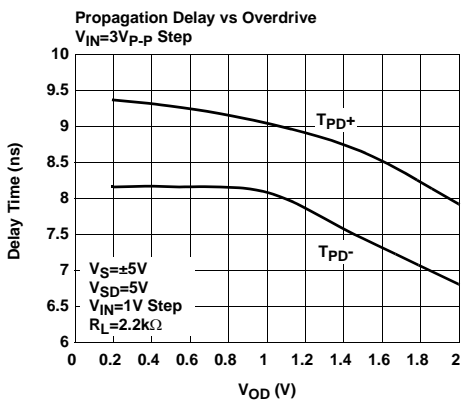
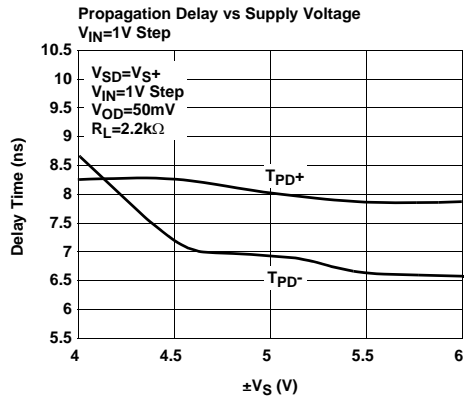
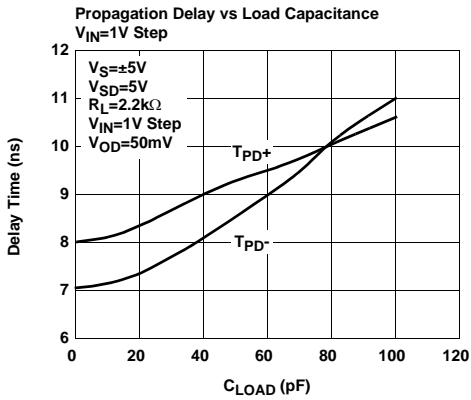

Typical Performance Curves (Continued)

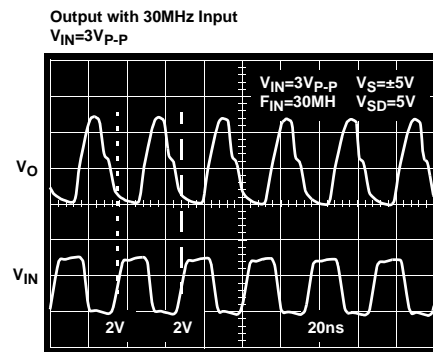
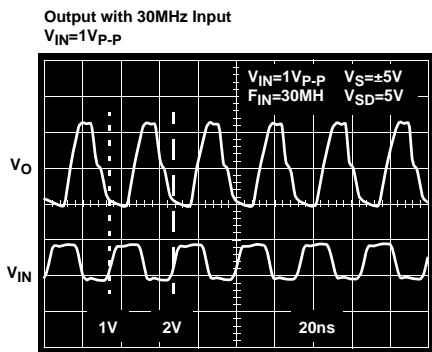
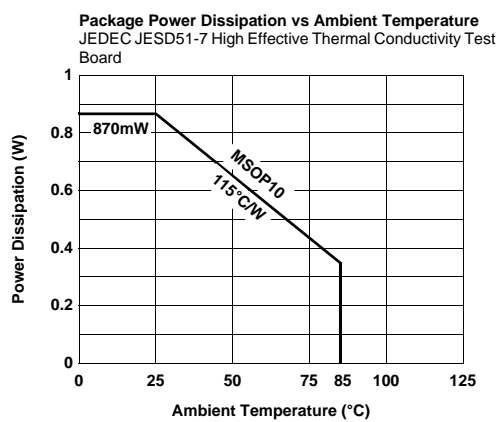
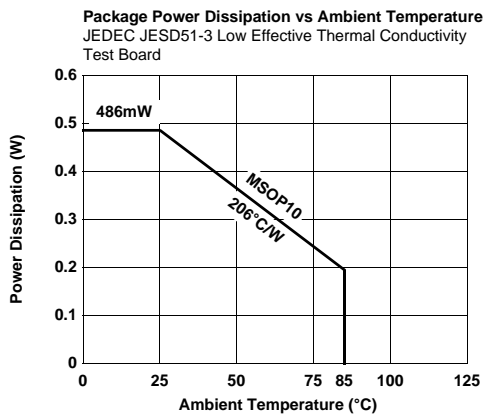
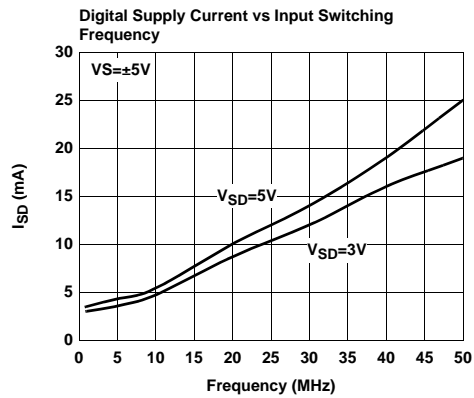
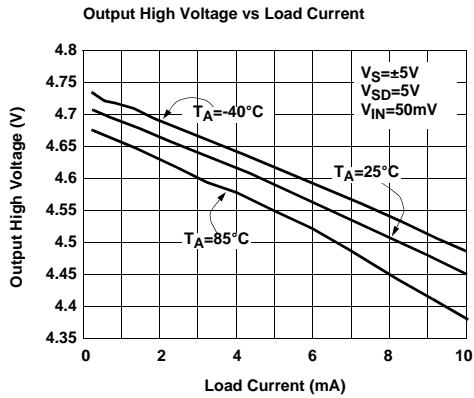

Timing Diagram

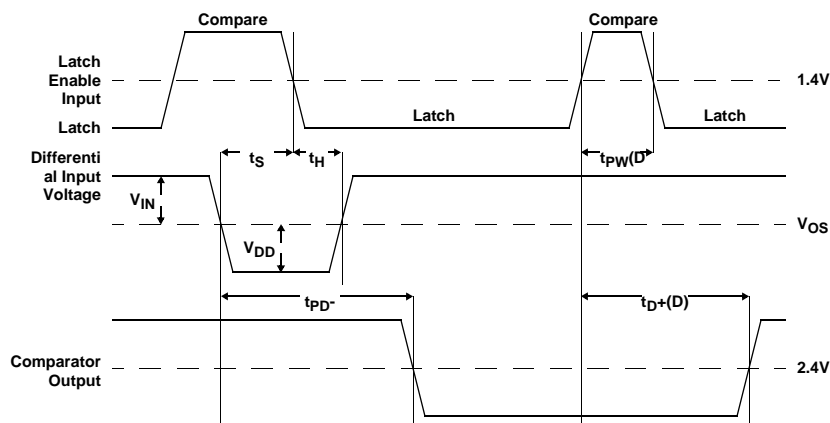

Definition of Terms

TERMS	DEFINITION
V_{OS}	Input Offset Voltage - Voltage applied between the two input terminals to obtain CMOS logic threshold at the output
V_{IN}	Input Voltage Pulse Amplitude - Usually set to 100mV for comparator specifications
V_{OD}	Input Voltage Overdrive - Usually set to 5mV and in opposite polarity to V_{IN} for comparator specifications
t_{PD+}	Input to Output High Delay - The propagation delay measured from the time the input signal crosses the input offset voltage to the CMOS logic threshold of an output low to high transition
t_{PD-}	Input to Output Low Delay - The propagation delay measured from the time the input signal crosses the input offset voltage to the CMOS logic threshold of an output high to low transition
t_{D+}	Latch Disable to Output High Delay - The propagation delay measured from the latch signal crossing the CMOS threshold in a low to high transition to the point of the output crossing CMOS threshold in a low to high transition
t_{D-}	Latch Disable to Output Low Delay - The propagation delay measured from the latch signal crossing the CMOS threshold in a low to high transition to the point of the output crossing CMOS threshold in a high to low transition
t_S	Minimum Setup Time - The minimum time before the negative transition of the latch signal that an input signal change must be present in order to be acquired and held at the outputs
t_H	Minimum Hold Time - The minimum time after the negative transition of the latch signal that an input signal must remain unchanged in order to be acquired and held at the output
$t_{PW(D)}$	Minimum Latch Disable Pulse Width - The minimum time that the latch signal must remain high in order to acquire and hold an input signal change

Pin Descriptions

PIN NUMBER	PIN NAME	FUNCTION	EQUIVALENT CIRCUIT
1	VS+	Positive supply voltage	
2	VREFH	Upper voltage reference	<p style="text-align: center;">Circuit 1</p>
3	IN	Input	(Reference Circuit 1)
4	VREFL	Lower voltage reference	(Reference Circuit 1)
5	VS-	Negative supply voltage	
6	GDN	Digital ground	
7	OUTL	Low output	<p style="text-align: center;">Circuit 2</p>
8	LATCH	Latch	<p style="text-align: center;">Circuit 3</p>
9	OUTH	High output	(Reference Circuit 2)
10	VSD	Digital supply voltage	

Applications Information

Power Supplies and Circuit Layout

The EL5283 comparator operates with single and dual supply with 5V to 12V between V_{S+} and V_{S-} . The output side of the comparators is supplied by a single supply from 2.7V to 5V. The rail to rail output swing enables direct connection of the comparator to both CMOS and TTL logic circuits. As with many high speed devices, the supplies must be well bypassed. Elantec recommends a 4.7 μ F tantalum in parallel with a 0.1 μ F ceramic. These should be placed as close as possible to the supply pins. Keep all leads short to reduce stray capacitance and lead inductance. This will also minimize unwanted parasitic feedback around the comparator. The device should be soldered directly to the PC board instead of using a socket. Use a PC board with a good, unbroken low inductance ground plane. Good ground

plane construction techniques enhance stability of the comparators.

Input Voltage Considerations

The EL5283 input range is specified from 0.1V below V_{S-} to 2.25V below V_{S+} . The criterion for the input limit is that the output still responds correctly to a small differential input signal. The differential input stage is a pair of PNP transistors, therefore, the input bias current flows out of the device. When either input signal falls below the negative input voltage limit, the parasitic PN junction formed by the substrate and the base of the PNP will turn on, resulting in a significant increase of input bias current. If one of the inputs goes above the positive input voltage limit, the output will still maintain the correct logic level as long as the other input stays within the input range. However, the propagation delay will increase. When both inputs are outside the input voltage range, the output becomes unpredictable. Large differential

voltages greater than the supply voltage should be avoided to prevent damages to the input stage.

Input Slew Rate

Most high speed comparators oscillate when the voltage of one of the inputs is close to or equal to the voltage on the other input due to noise or undesirable feedback. For clean output waveform, the input must meet certain minimum slew rate requirements. In some applications, it may be helpful to apply some positive feedback (hysteresis) between the output and the positive input. The hysteresis effectively causes one comparator's input voltage to move quickly past the other, thus taking the input out of the region where oscillation occurs. For the EL5283, the propagation delay increases when the input slew rate increases for low overdrive voltages. With high overdrive voltages, the propagation delay does not change much with the input slew rate.

Latch Pin Dynamics

The EL5283 contains a “transparent” latch for each channel. The latch pin is designed to be driven with either a TTL or CMOS output. When the latch is connected to a logic high level or left floating, the comparator is transparent and immediately responds to the changes at the input terminals. When the latch is switched to a logic low level, the comparator output latches remains latched to its value just before the latch high-to-low transition. To guarantee data retention, the input signal must remain the same state at least 1 ns (hold time) after the latch goes low and at least 2ns (setup time) before the latch goes high. When the latch goes high, the new data will appear at the output in approximately 6ns (latch propagation delay).

Power Dissipation

When switching at high speeds, the comparator's drive capability is limited by the rise in junction temperature caused by the internal power dissipation. For reliable operation, the junction temperature must be kept below T_{JMAX} (125°C).

An approximate equation for the device power dissipation is as follows. Assume the power dissipation in the load is very small:

$$P_{DISS} = (V_S \times I_S + V_{SD} \times I_{SD}) \times N$$

where:

V_S is the analog supply voltage from V_{S+} to V_{S-}

I_S is the analog quiescent supply current per comparator

V_{SD} is the digital supply voltage from V_{SD} to ground

I_{SD} is the digital supply current per comparator

N is the number of comparators in the package

I_{SD} strongly depends on the input switching frequency. Please refer to the performance curve to choose the input driving frequency. Having obtained the power dissipation, the maximum junction temperature can be determined as follows:

$$T_{JMAX} = T_{MAX} + \theta_{JA} \times P_{DISS}$$

where:

T_{MAX} is the maximum ambient temperature

θ_{JA} is the thermal resistance of the package

Window Detector

If V_{IN} is in the range of V_{REFL} < V_{IN} < V_{REFH}, both outputs go high and the input in range is high. If V_{IN} is out of the range set by V_{REFH} and V_{REFL}, the input in range is low.

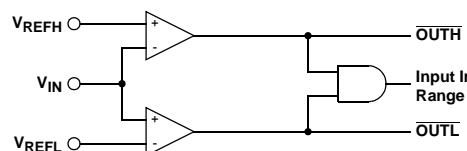

All Intersil U.S. products are manufactured, assembled and tested utilizing ISO9000 quality systems. Intersil Corporation's quality certifications can be viewed at www.intersil.com/design/quality

Intersil products are sold by description only. Intersil Corporation reserves the right to make changes in circuit design, software and/or specifications at any time without notice. Accordingly, the reader is cautioned to verify that data sheets are current before placing orders. Information furnished by Intersil is believed to be accurate and reliable. However, no responsibility is assumed by Intersil or its subsidiaries for its use; nor for any infringements of patents or other rights of third parties which may result from its use. No license is granted by implication or otherwise under any patent or patent rights of Intersil or its subsidiaries.

For information regarding Intersil Corporation and its products, see www.intersil.com